

Industrial & Systems Engineering 25-26 Catalog Year

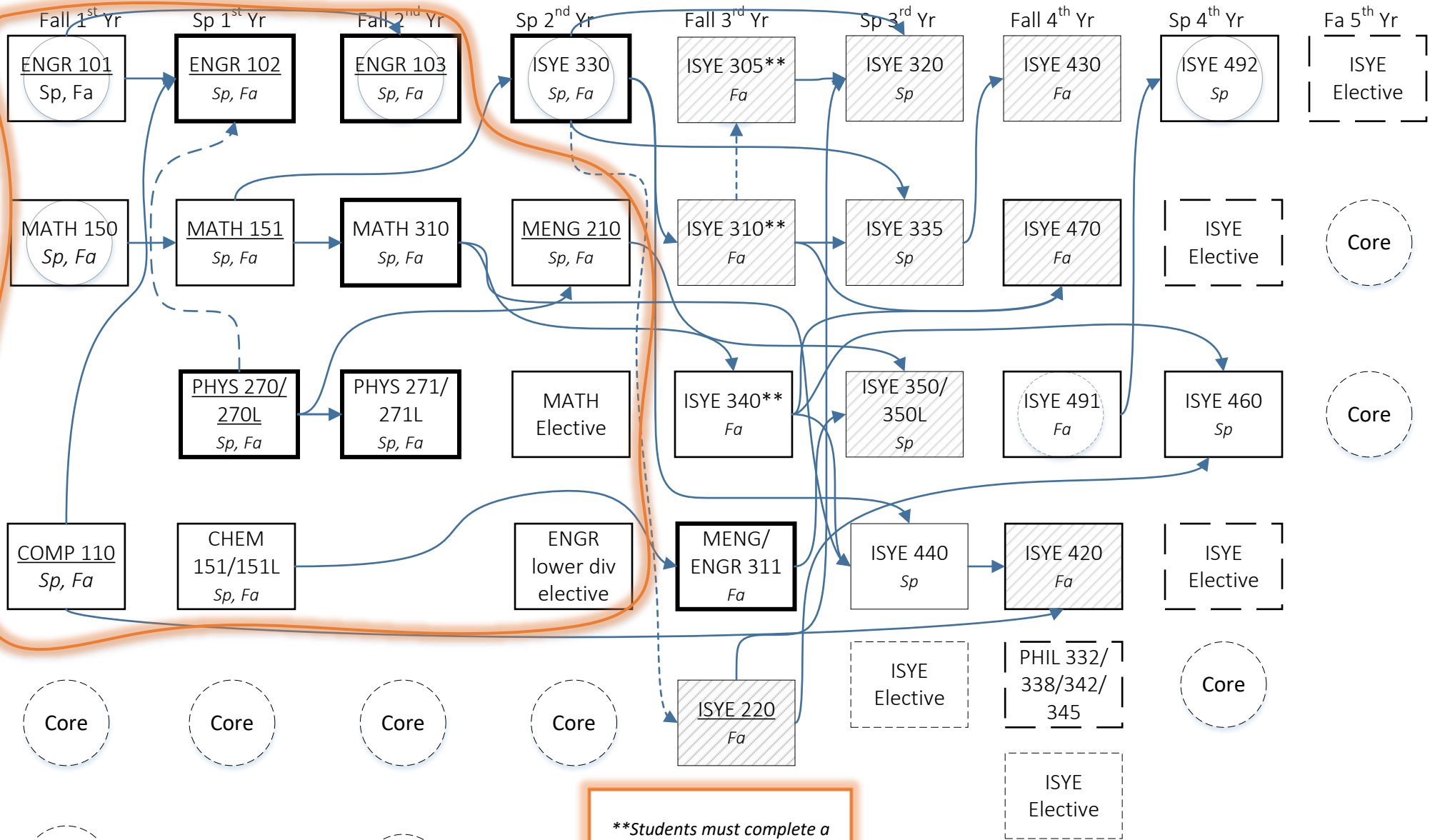

****Students must complete a minimum of 34 units of required Math, Science, and Engineering Core to take ISYE 310, ISYE 340, ISYE 305.**

- Underlined courses have MATH 150 Co/Prereq
- Bold Outline have MATH 151 Co/Prereq
- Stripe filled courses are prereqs/coreqs for ISYE 491
- Solid arrows = Prereq; dashed arrows = Coreq
- Dashed outlines can be taken in any semester



Total Major Units	10.5	15	10	12	16	17	16	12	3
Recommended Total Units	16	18	16	18	16	17	16	15	15