

Electrical Engineering 25-26 Catalog Year

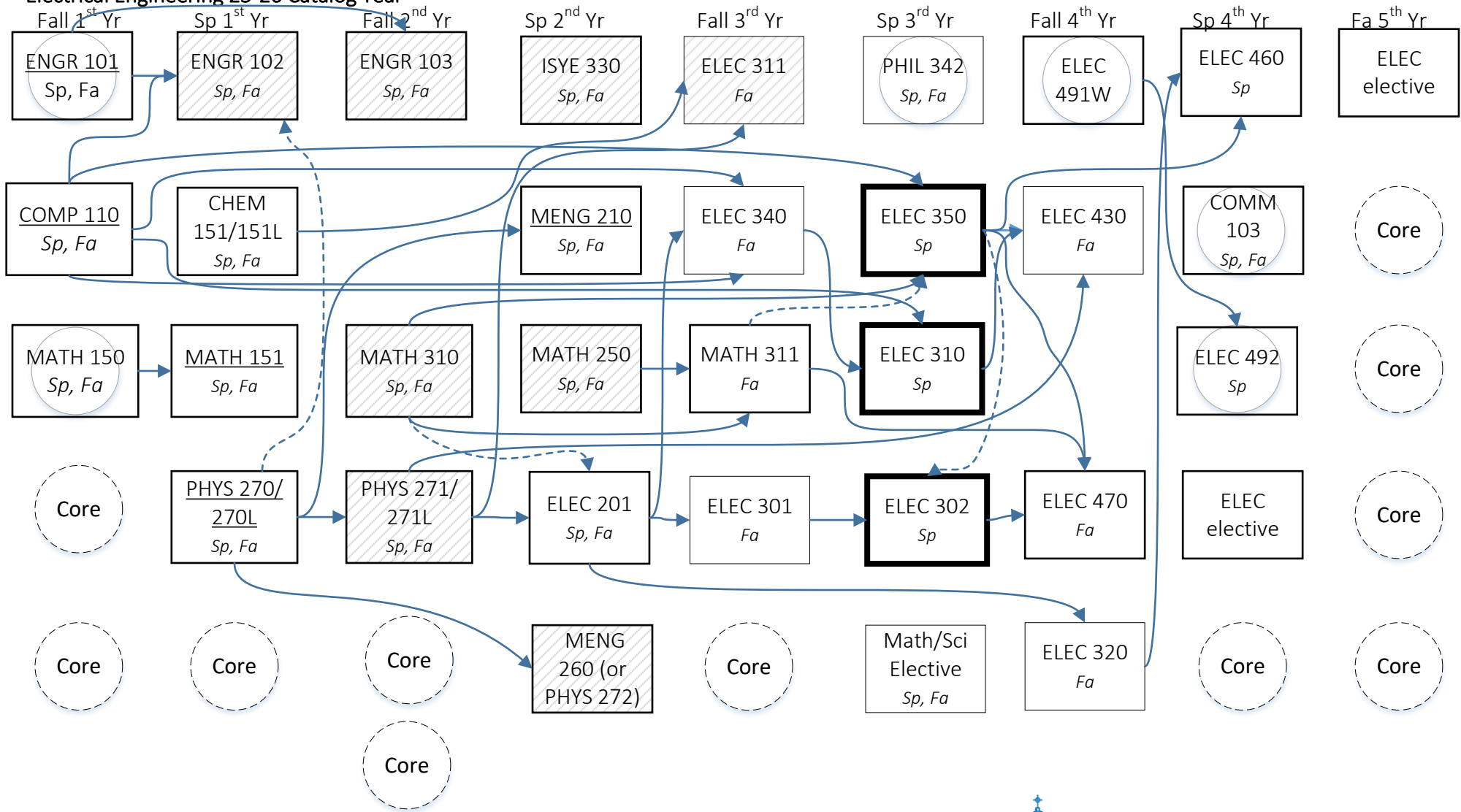

- Bold** Outline courses are Senior Design Co/Prereqs
- Underlined courses have MATH 150 Co/Prereq
- Lined backgrounds have a MATH 151 Co/Prereq
- Solid arrows = Prereq; dashed arrows = Coreq

Total Major Units

| | | | | | | | | |
|--------------------------------|----|----|----|----|----|----|----|----|
| 10 | 15 | 10 | 17 | 17 | 11 | 15 | 13 | 3 |
| Recommended Total Units | | | | | | | | |
| 16 | 18 | 16 | 17 | 17 | 17 | 15 | 16 | 15 |